

SCALE:
NTS
UNLESS NOTED OTHERWISE

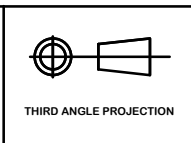

© COPYRIGHT LOTUS FOLDING WALLS & DOORS PTY LTD.
REPRODUCTION PROHIBITED WITHOUT PERMISSION. CHANGES TO THE DESIGN AND OR DETAILS OF THIS DRAWING MUST NOT BE MADE WITHOUT PERMISSION OF THE R&D DEPARTMENT MANAGER. DO NOT SCALE FROM THIS DRAWING. CHECK ALL DIMENSIONS WITH THE R&D DEPARTMENT MANAGER.
WWW.LOTUSDOORS.COM.AU ABN 61 007 087 523



PRODUCT:
100 SERIES OPERA



TITLE:
100 -1 TRACK WITH SWEEP SEALS

DRAWING NUMBER:
TSD-OP-100-0001

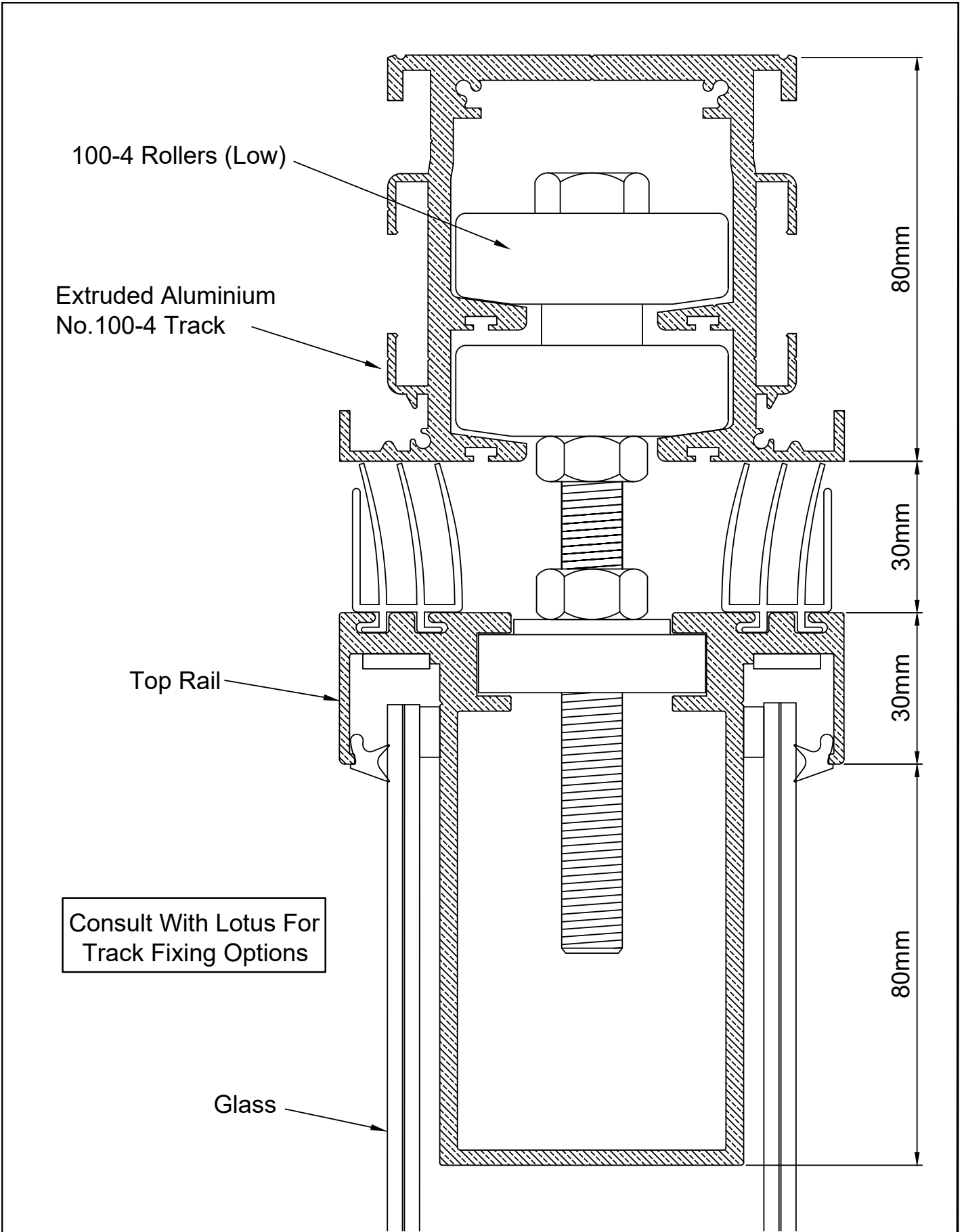

LATEST REVISION DATE:
19/11/2019

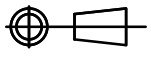
REV
2

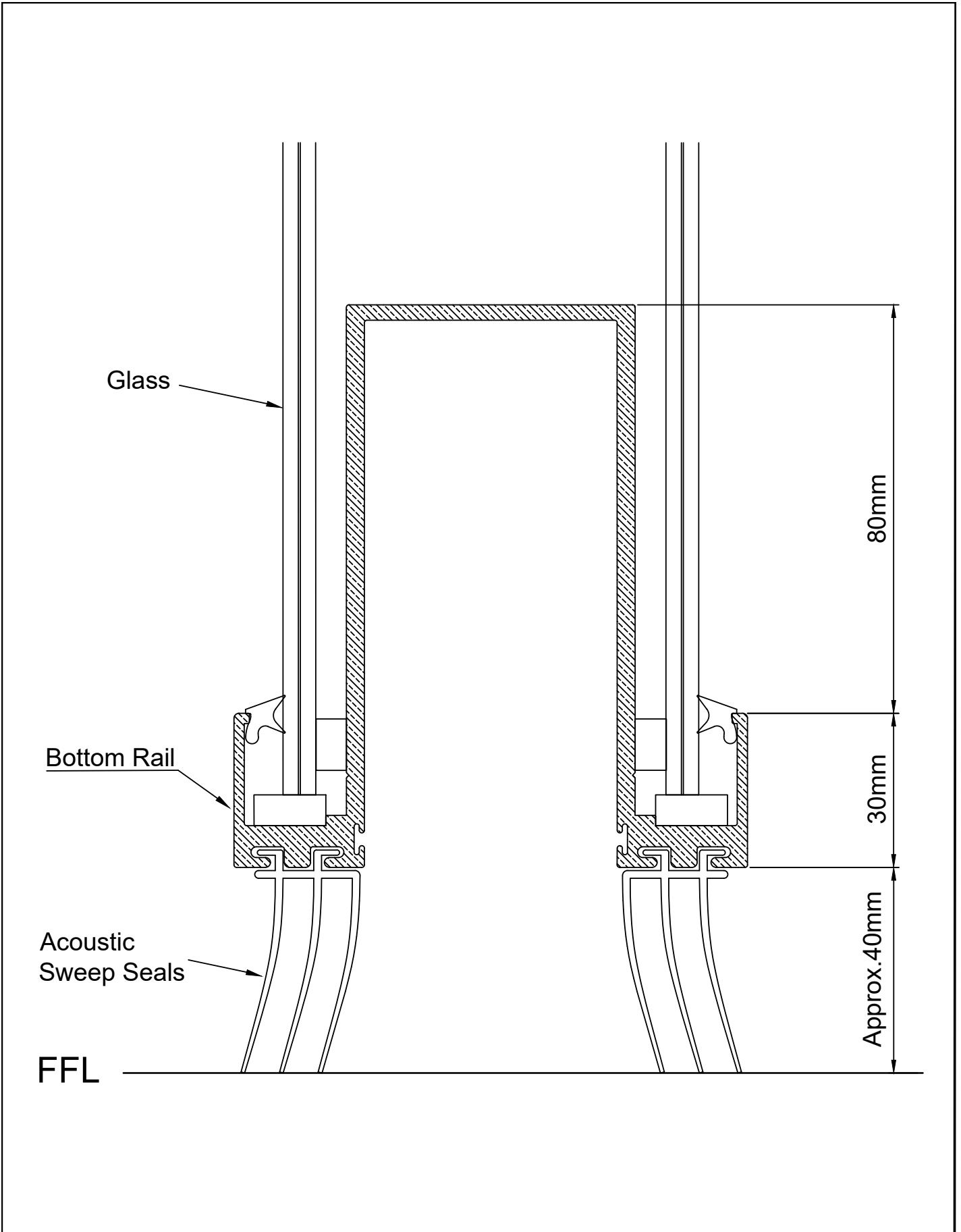

<p>SCALE: NTS UNLESS NOTED OTHERWISE</p>	 <p>THIRD ANGLE PROJECTION</p>	<p>© COPYRIGHT LOTUS FOLDING WALLS & DOORS PTY LTD. REPRODUCTION PROHIBITED WITHOUT PERMISSION. CHANGES TO THE DESIGN AND OR DETAILS OF THIS DRAWING MUST NOT BE MADE WITHOUT PERMISSION OF THE R&D DEPARTMENT MANAGER. DO NOT SCALE FROM THIS DRAWING. CHECK ALL DIMENSIONS WITH THE R&D DEPARTMENT MANAGER. WWW.LOTUSDOORS.COM.AU ABN 61 007 087 523</p>		
<p>PRODUCT: 100 SERIES OPERA</p>	<p>TITLE: 100-4 TRACK WITH SWEEP SEALS</p>	<p>DRAWING NUMBER: TSD-OP-100-002</p>	<p>LATEST REVISION DATE: 19/11/2019</p>	<p>REV 2</p>

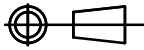

<p>SCALE: NTS UNLESS NOTED OTHERWISE</p>	 <p>THIRD ANGLE PROJECTION</p>	<p>© COPYRIGHT LOTUS FOLDING WALLS & DOORS PTY LTD. REPRODUCTION PROHIBITED WITHOUT PERMISSION. CHANGES TO THE DESIGN AND OR DETAILS OF THIS DRAWING MUST NOT BE MADE WITHOUT PERMISSION OF THE R&D DEPARTMENT MANAGER. DO NOT SCALE FROM THIS DRAWING. CHECK ALL DIMENSIONS WITH THE R&D DEPARTMENT MANAGER. WWW.LOTUSDOORS.COM.AU ABN 61 007 087 523</p>		
<p>PRODUCT: 100 SERIES OPERA</p>	<p>TITLE: BOTTOM RAIL WITH SWEEP SEALS</p>	<p>DRAWING NUMBER: TSD-OP-100-0003</p>	<p>LATEST REVISION DATE: 19/11/2019</p>	<p>REV 2</p>

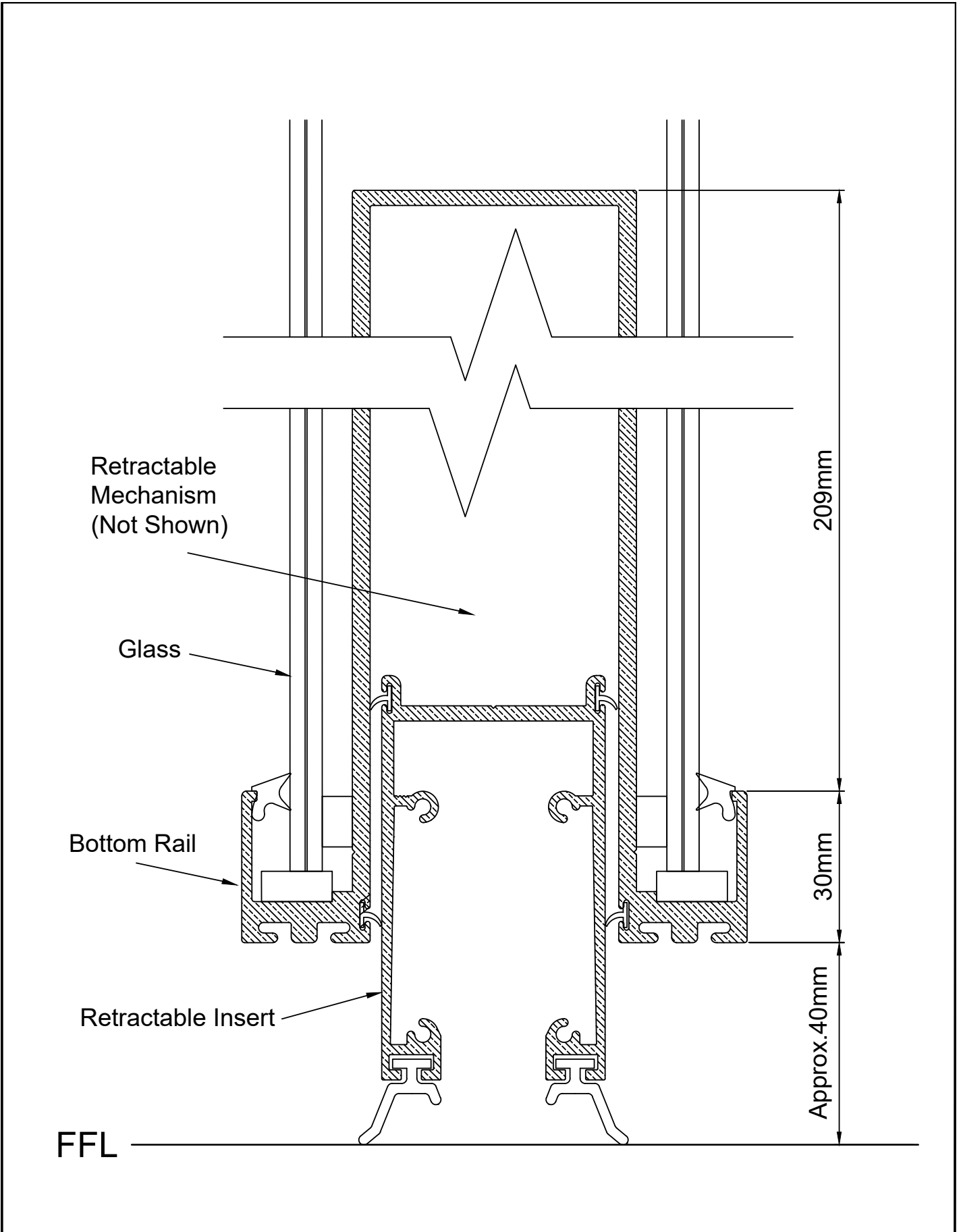

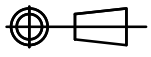
<p>SCALE: NTS UNLESS NOTED OTHERWISE</p>	 <p>THIRD ANGLE PROJECTION</p>	<p>© COPYRIGHT LOTUS FOLDING WALLS & DOORS PTY LTD. REPRODUCTION PROHIBITED WITHOUT PERMISSION. CHANGES TO THE DESIGN AND OR DETAILS OF THIS DRAWING MUST NOT BE MADE WITHOUT PERMISSION OF THE R&D DEPARTMENT MANAGER. DO NOT SCALE FROM THIS DRAWING. CHECK ALL DIMENSIONS WITH THE R&D DEPARTMENT MANAGER. WWW.LOTUSDOORS.COM.AU ABN 61 007 087 523</p>	<h1>LOTUS</h1>	
<p>PRODUCT: 100 SERIES OPERA</p>	<p>TITLE: BOTTOM RETRACTABLE SEALS</p>	<p>DRAWING NUMBER: TSD-OP-100-004</p>	<p>LATEST REVISION DATE: 19/11/2019</p>	<p>REV 2</p>

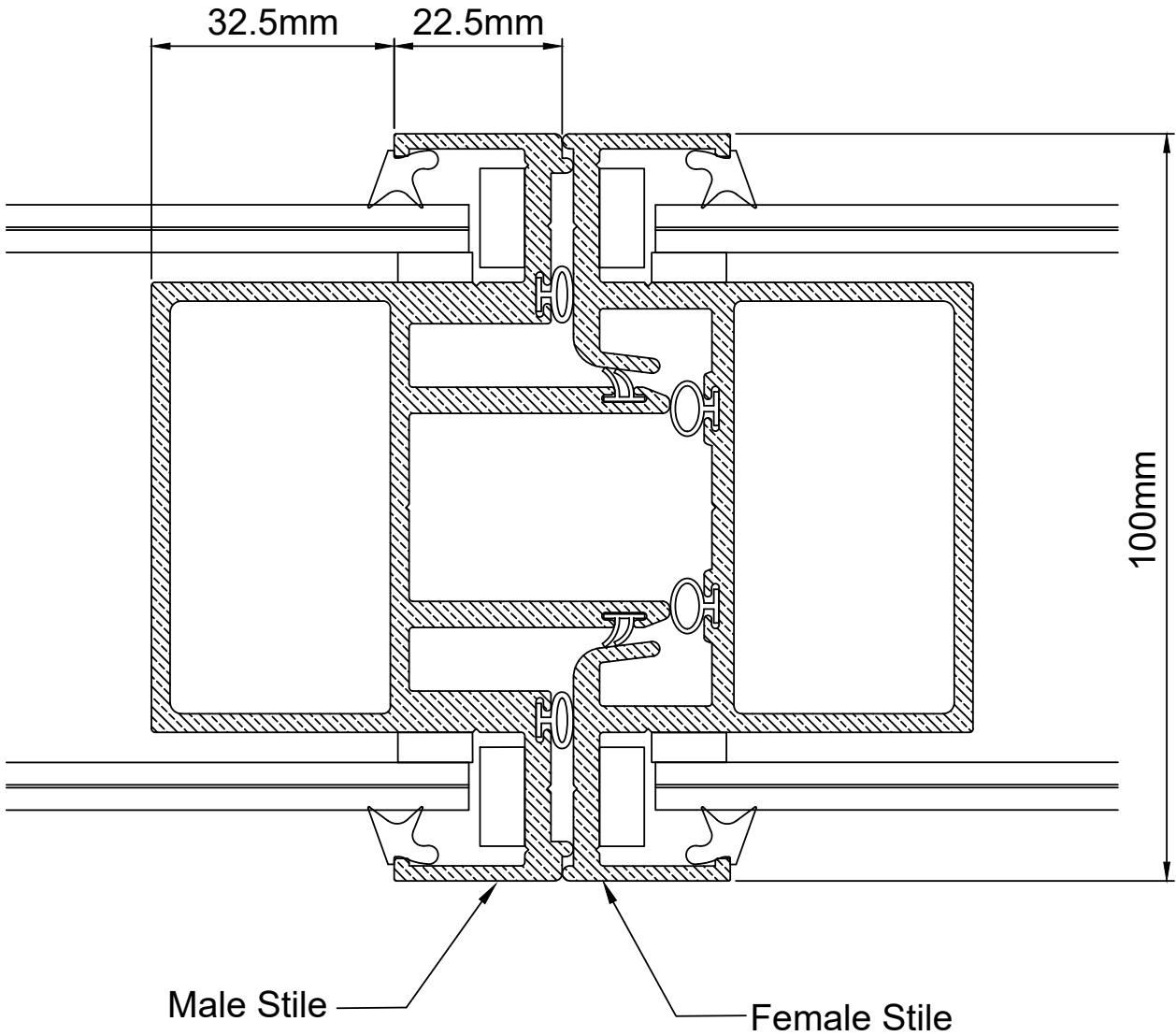

SCALE:
NTS
UNLESS NOTED OTHERWISE

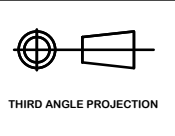

© COPYRIGHT LOTUS FOLDING WALLS & DOORS PTY LTD.
REPRODUCTION PROHIBITED WITHOUT PERMISSION. CHANGES TO THE DESIGN AND OR DETAILS OF THIS DRAWING MUST NOT BE MADE WITHOUT PERMISSION OF THE R&D DEPARTMENT MANAGER. DO NOT SCALE FROM THIS DRAWING. CHECK ALL DIMENSIONS WITH THE R&D DEPARTMENT MANAGER.
WWW.LOTUSDOORS.COM.AU ABN 61 007 087 523



PRODUCT:
100 SERIES OPERA

TITLE:
PANEL JUNCTION

DRAWING NUMBER:
TSD-OP-100-0005

LATEST REVISION DATE:
19/11/2019

REV
2

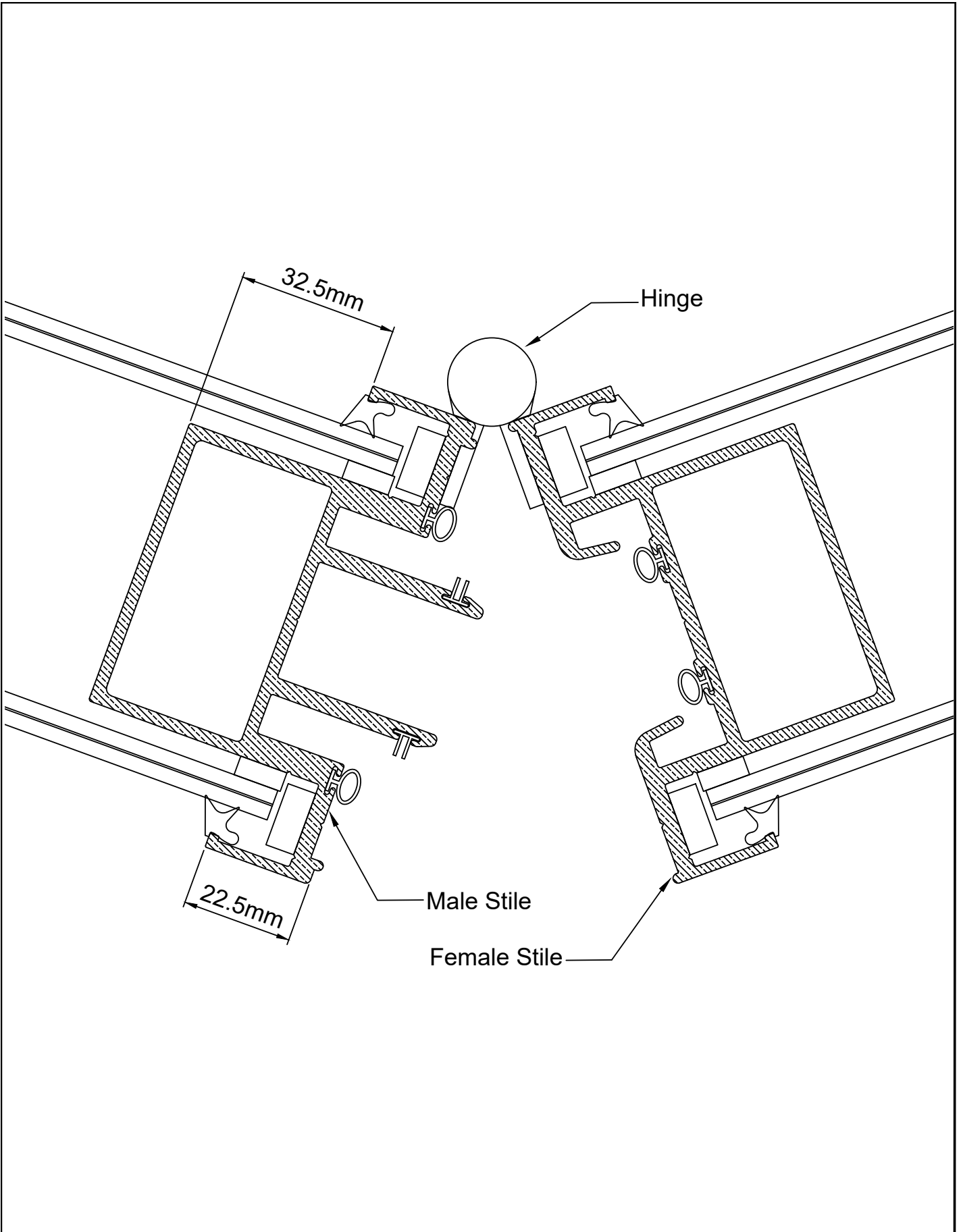

SCALE:
NTS
UNLESS NOTED OTHERWISE

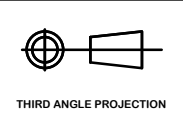

© COPYRIGHT LOTUS FOLDING WALLS & DOORS PTY LTD.
REPRODUCTION PROHIBITED WITHOUT PERMISSION. CHANGES TO THE DESIGN AND OR DETAILS OF THIS DRAWING MUST NOT BE MADE WITHOUT PERMISSION OF THE R&D DEPARTMENT MANAGER. DO NOT SCALE FROM THIS DRAWING. CHECK ALL DIMENSIONS WITH THE R&D DEPARTMENT MANAGER.
WWW.LOTUSDOORS.COM.AU ABN 61 007 087 523



PRODUCT:
100 SERIES OPERA

TITLE:
PANEL JUNCTION - HINGED PAIR



DRAWING NUMBER:
TSD-OP-100-0006

LATEST REVISION DATE:
19/11/2019

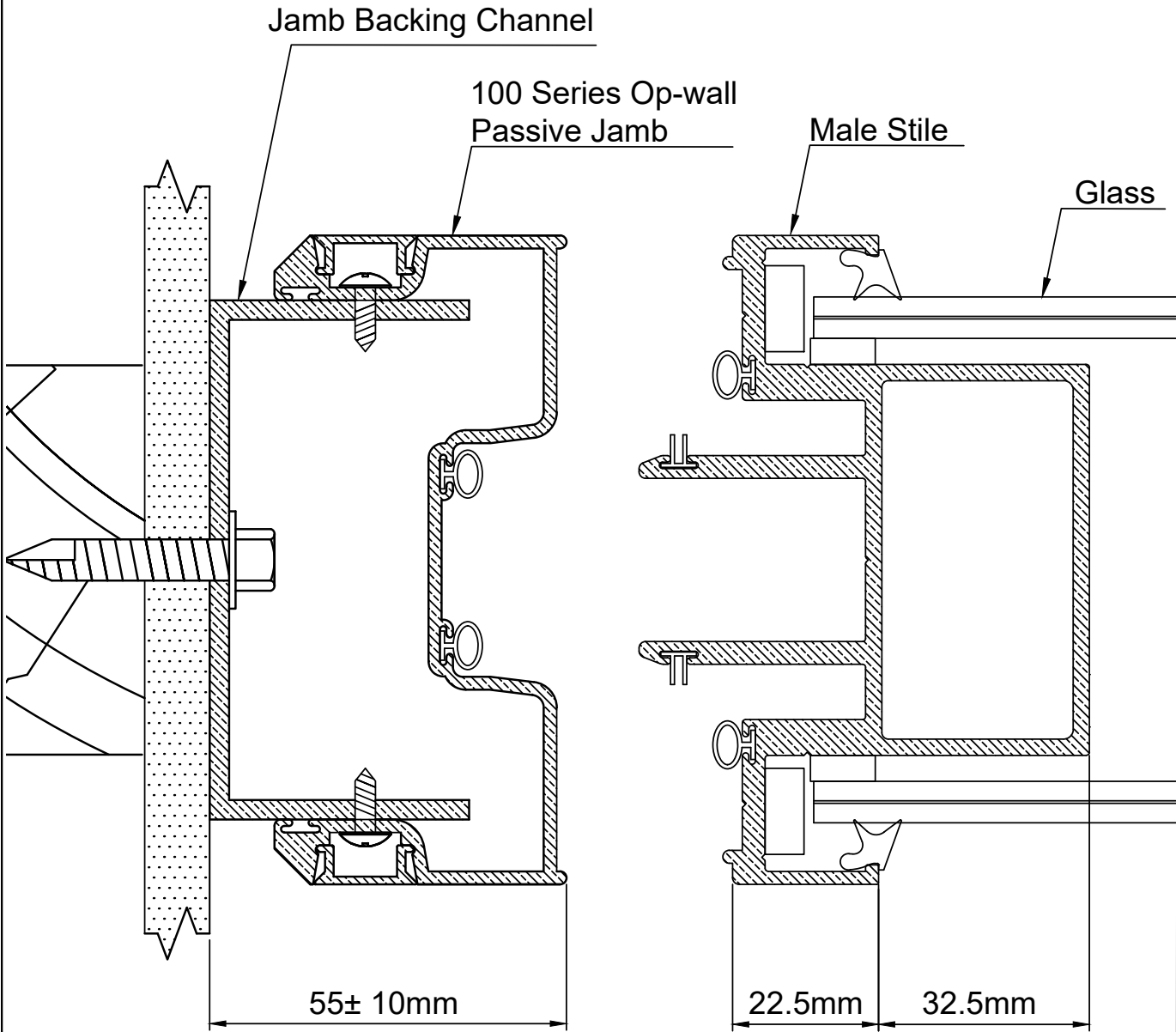

REV
2

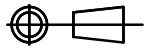
Consult With Lotus For Jamb Fixing Options



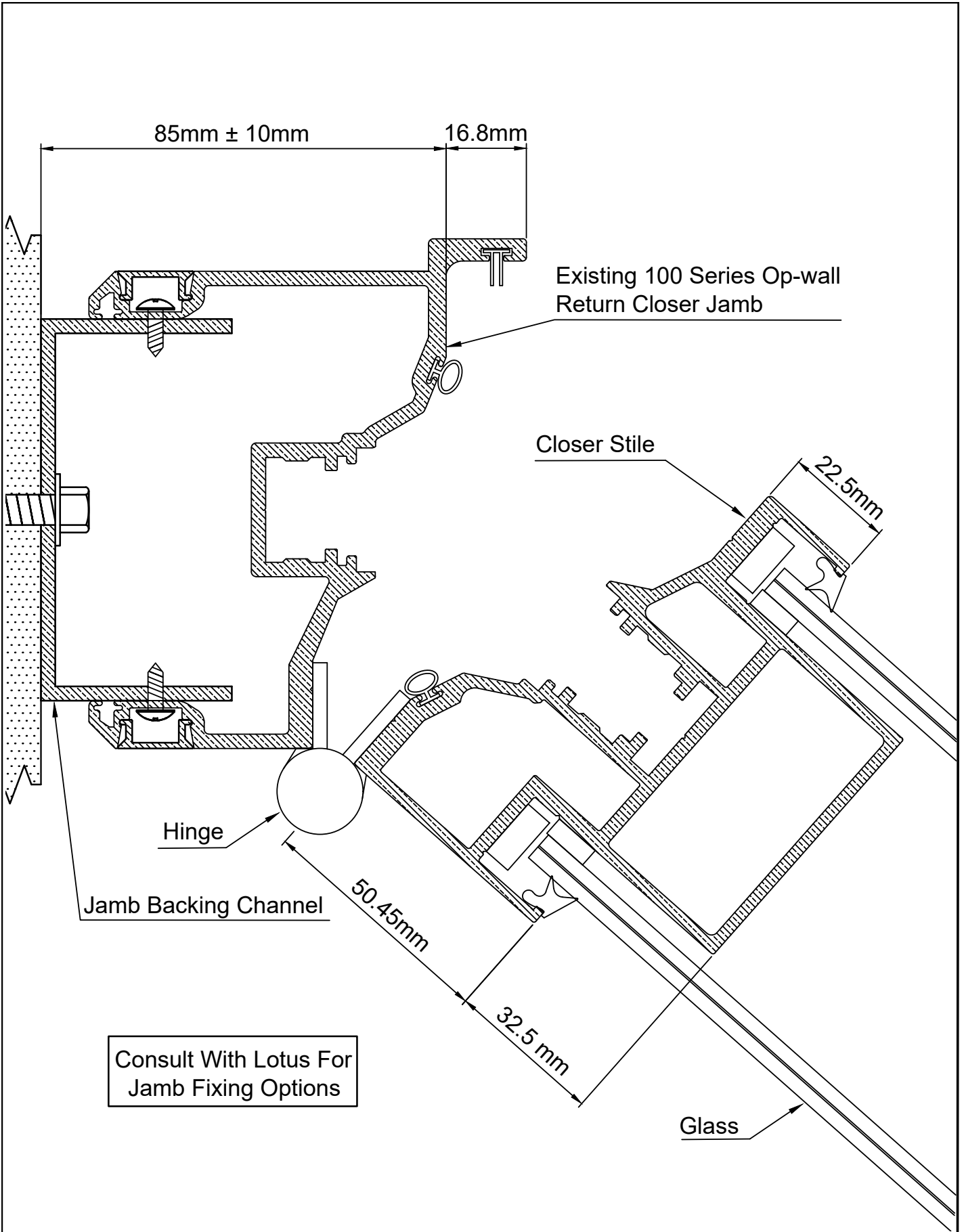

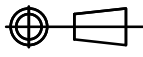
<p>SCALE: NTS</p> <p>UNLESS NOTED OTHERWISE</p>	 <p>THIRD ANGLE PROJECTION</p>	<p>© COPYRIGHT LOTUS FOLDING WALLS & DOORS PTY LTD. REPRODUCTION PROHIBITED WITHOUT PERMISSION. CHANGES TO THE DESIGN AND OR DETAILS OF THIS DRAWING MUST NOT BE MADE WITHOUT PERMISSION OF THE R&D DEPARTMENT MANAGER. DO NOT SCALE FROM THIS DRAWING. CHECK ALL DIMENSIONS WITH THE R&D DEPARTMENT MANAGER.</p> <p>WWW.LOTUSDOORS.COM.AU ABN 61 007 087 523</p>		
<p>PRODUCT: 100 SERIES OPERA</p>	<p>TITLE: PASSIVE JAMB</p>	<p>DRAWING NUMBER: TSD-OP-100-0007</p>	<p>LATEST REVISION DATE: 19/11/2019</p>	<p>REV 2</p>



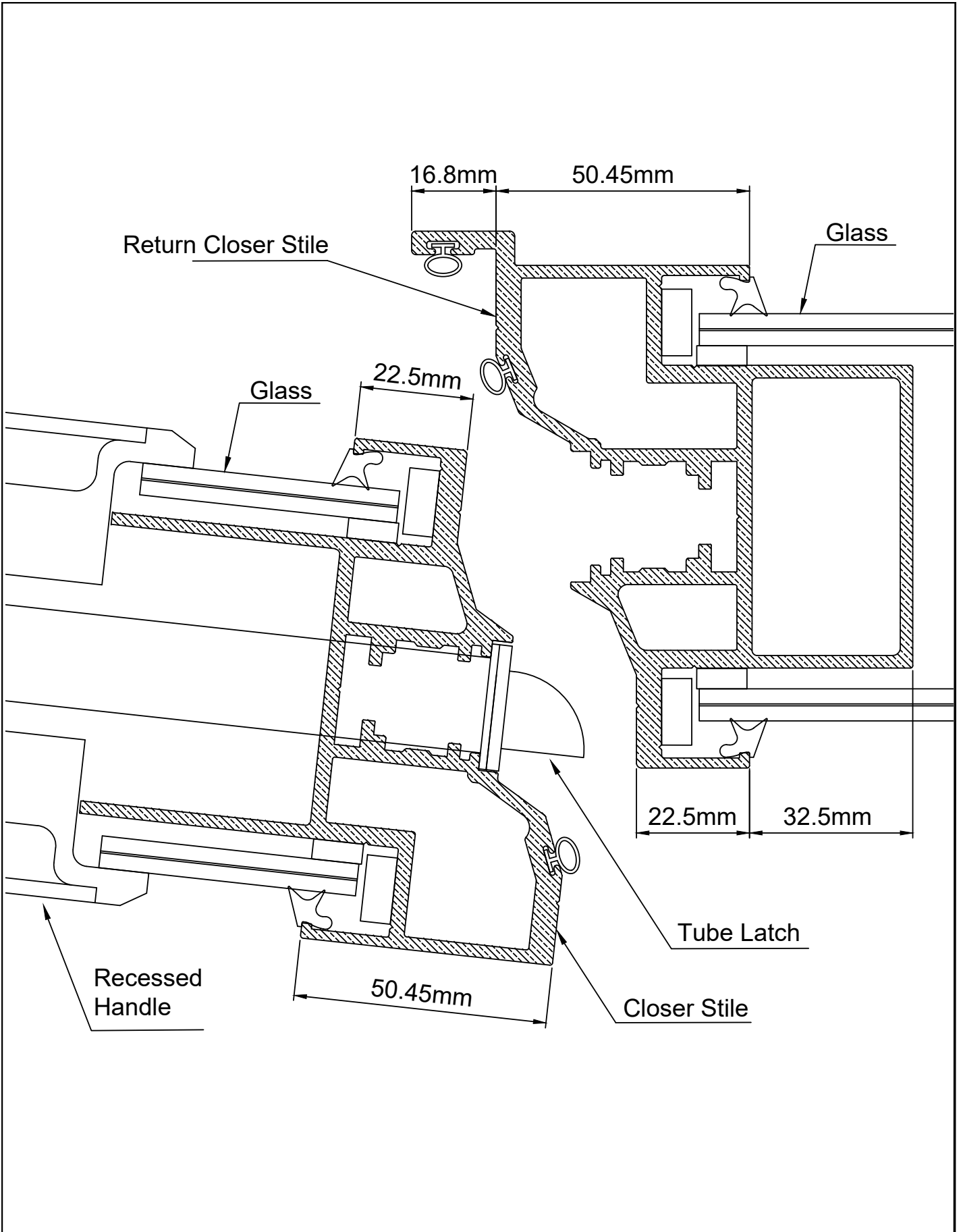

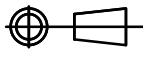
<p>SCALE: NTS UNLESS NOTED OTHERWISE</p>	 <p>THIRD ANGLE PROJECTION</p>	<p>© COPYRIGHT LOTUS FOLDING WALLS & DOORS PTY LTD. REPRODUCTION PROHIBITED WITHOUT PERMISSION. CHANGES TO THE DESIGN AND OR DETAILS OF THIS DRAWING MUST NOT BE MADE WITHOUT PERMISSION OF THE R&D DEPARTMENT MANAGER. DO NOT SCALE FROM THIS DRAWING. CHECK ALL DIMENSIONS WITH THE R&D DEPARTMENT MANAGER. WWW.LOTUSDOORS.COM.AU ABN 61 007 087 523</p>		
<p>PRODUCT: 100 SERIES OPERA</p>	<p>TITLE: RETURN CLOSER JAMB</p>	<p>DRAWING NUMBER: TSD-OP-100-0008</p>	<p>LATEST REVISION DATE: 19/11/2019</p>	<p>REV 2</p>

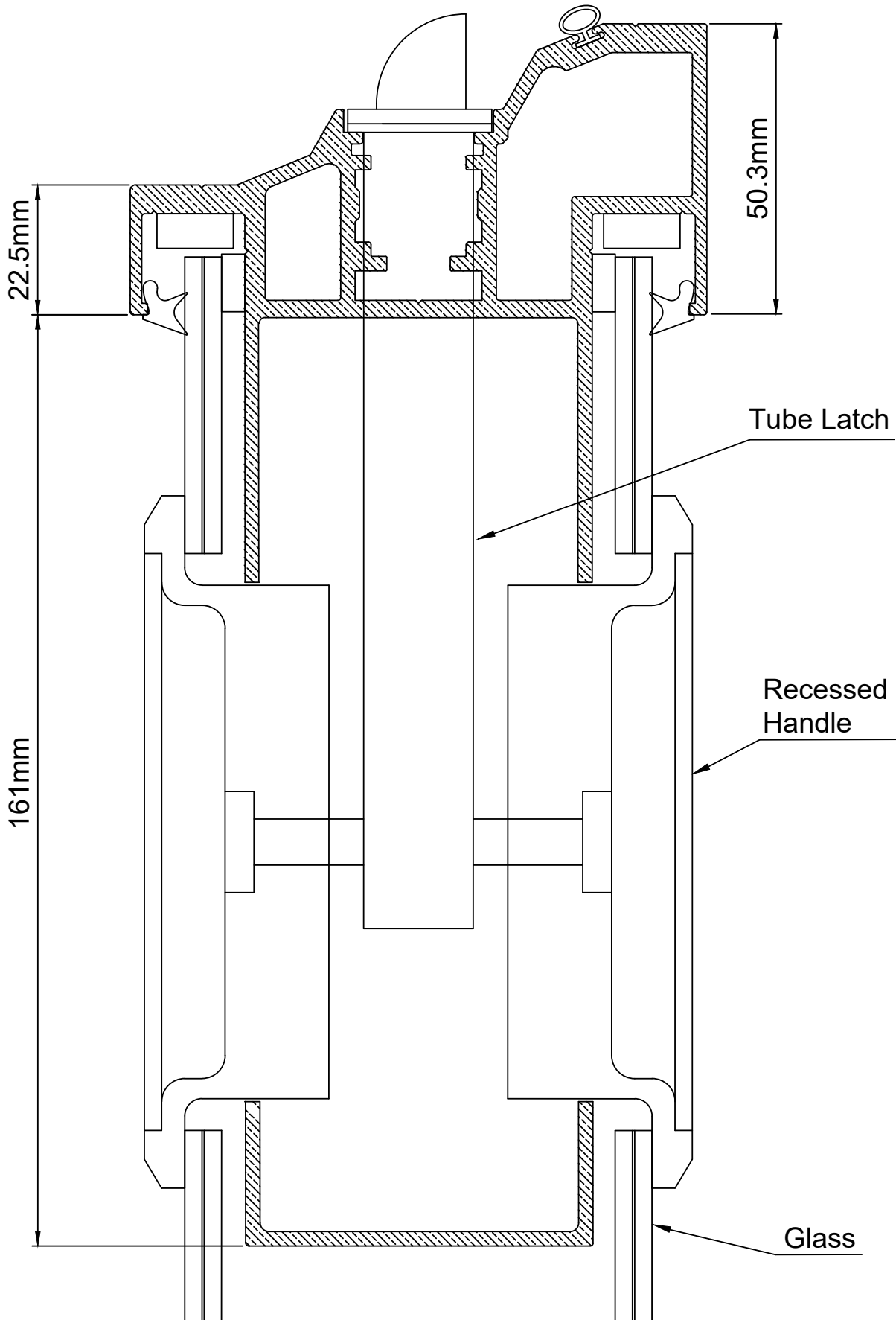

<p>SCALE: NTS UNLESS NOTED OTHERWISE</p>	 <p>THIRD ANGLE PROJECTION</p>	<p>© COPYRIGHT LOTUS FOLDING WALLS & DOORS PTY LTD. REPRODUCTION PROHIBITED WITHOUT PERMISSION. CHANGES TO THE DESIGN AND OR DETAILS OF THIS DRAWING MUST NOT BE MADE WITHOUT PERMISSION OF THE R&D DEPARTMENT MANAGER. DO NOT SCALE FROM THIS DRAWING. CHECK ALL DIMENSIONS WITH THE R&D DEPARTMENT MANAGER. WWW.LOTUSDOORS.COM.AU ABN 61 007 087 523</p>		
<p>PRODUCT: 100 SERIES OPERA</p>	<p>TITLE: PASSDOOR CLOSING ONTO ADJ. PANEL</p>	<p>DRAWING NUMBER: TSD-OP-100-0010</p>	<p>LATEST REVISION DATE: 19/11/2019</p>	<p>REV 2</p>

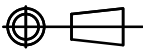

<p>SCALE: NTS</p> <p>UNLESS NOTED OTHERWISE</p>	 <p>THIRD ANGLE PROJECTION</p>	<p>© COPYRIGHT LOTUS FOLDING WALLS & DOORS PTY LTD. REPRODUCTION PROHIBITED WITHOUT PERMISSION. CHANGES TO THE DESIGN AND OR DETAILS OF THIS DRAWING MUST NOT BE MADE WITHOUT PERMISSION OF THE R&D DEPARTMENT MANAGER. DO NOT SCALE FROM THIS DRAWING. CHECK ALL DIMENSIONS WITH THE R&D DEPARTMENT MANAGER.</p> <p>WWW.LOTUSDOORS.COM.AU ABN 61 007 087 523</p>		
<p>PRODUCT: 100 SERIES OPERA</p>	<p>TITLE: CLOSER STILE - HANDLE</p>	<p>DRAWING NUMBER: TSD-OP-100-0011</p>	<p>LATEST REVISION DATE: 19/11/2019</p>	<p>REV 2</p>